

Refrigeration Air Dryer



Clean, Dry and Reliable Compressed Air

Moisture in the compressed air will causes major quality issues and expensive damages to the user such as premature wear and failure in pneumatic equipment, spoiled products and damaged control system. Having a clean, dry and reliable compressed air supply is essential to maintain efficient and low operating cost.

PSI provide completes compressed air treatment solutions with end user in mind. PFD refrigeration dryer is designed to remove water vapour from the compressed air by cooling through a highly efficient refrigerant circuit. PFD provides air quality in accordance with ISO8573.1 Class 4 for water vapour.

FEATURE

Easy Installation & Maintenance

PFD has been designed with end user in mind and with easily and fast removable panel, user can easy access to the internal major refrigeration components for maintenance and cleaning.

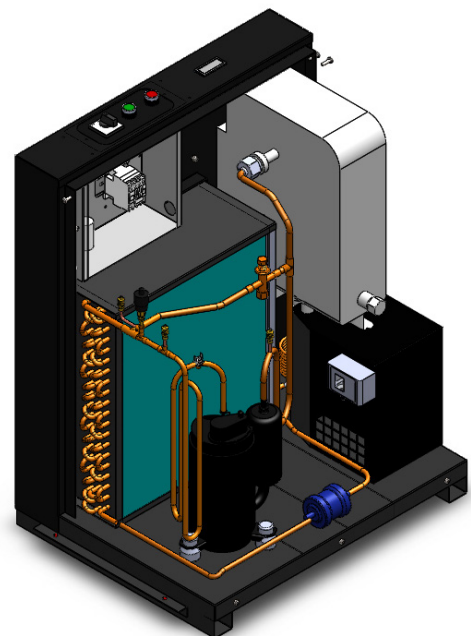

Simple and User Friendly Control

PFD simple refrigeration system and mechanical control allows it to be “Plug and Play”. Colour dew point indicator (Standard for PFD36 – PFD600) allow user easily monitor the dryer performance.

Reliable Operation

Reliable and quality components and refrigeration compressors.

Environmentally Friendly Refrigerant

PFD uses only R134a or R407C environmentally friendly HFC refrigerant.

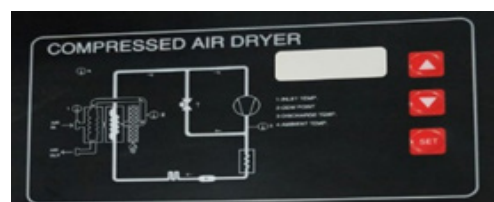

Electronic Display Board

Electronic display board (standard for PFD720 and above) displaying inlet air temperature, dew point, refrigerant compressor discharge temperature and ambient/ cooling water temperature.

Heat Exchanger

High efficiency reinforced aluminium heat exchanger is used for PFD330 and above allows the refrigerant circuit to be 30% smaller than traditional refrigeration system and less energy consumption.

Stage 1 Air to Air Heat Exchanger

There are two phases (Pre-cool / Re-heat) in the air to air heat exchanger. The inlet air is pre-cooled by the outlet cold air whereby heat is being transfer to cold air. It reduce the energy consumption required by the refrigerant as portion of the heat load has been removed. At the same time by re-heating the cold air before it was supply to the production, it reduces the possibility of condensation at the external surface of the dryer outlet pipe.

Stage 2 Air to Refrigerant Heat Exchanger

The pre-cooled air will be further cool to the required dew point by transferring heat to the cold refrigerant in the air to refrigerant heat exchanger. The cold air will then be directed to the high efficiency moisture separator.

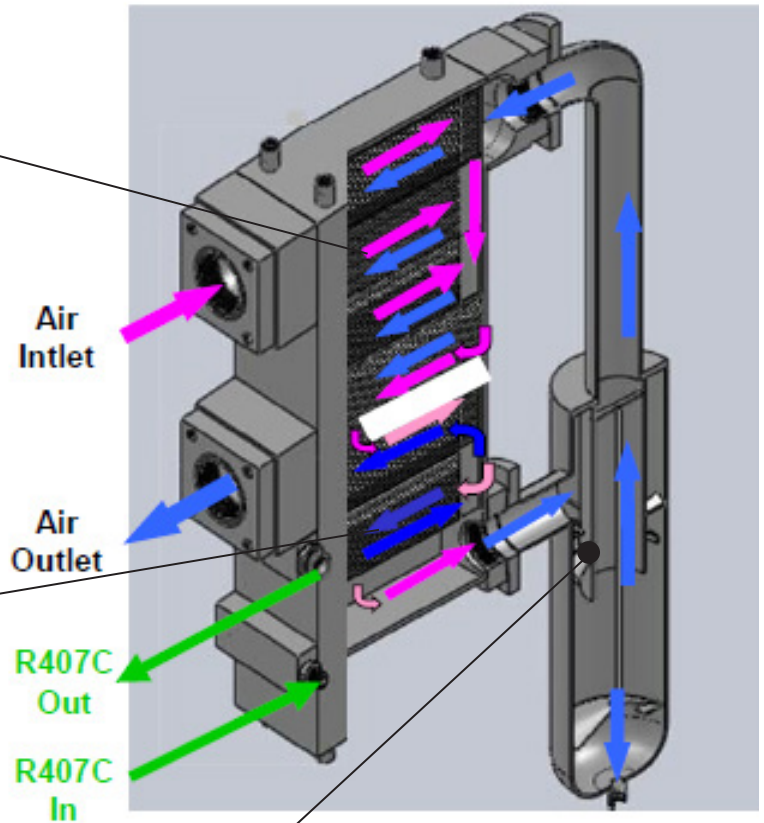

Stage 3 High Efficiency Moisture Separator

The cold air passed through the high efficiency moisture separator and condensate will be removed from the compressed air before being supply to production.



Stainless Steel Plated Heat Exchanger

Stainless steel plated heat exchanger is used for PFD36 – PFD240 and high-pressure PFD.

Technical Data PFD36 -PFD240

Model	Air Connection	Power Supply	Nominal Flow Rate		Dimensions (mm)			Weight (kg)
			cfm	m ³ /h	L	W	H	
PFD36	Rc 1/2"	230V/1Ph/50Hz	21	36	500	250	500	25
PFD54	Rc 1/2"	230V/1Ph/50Hz	32	54	500	250	500	25
PFD72	Rc 1/2"	230V/1Ph/50Hz	42	72	600	310	500	30
PFD90	Rc 1/2"	230V/1Ph/50Hz	53	90	600	310	500	30
PFD108	Rc 1/2"	230V/1Ph/50Hz	64	108	600	310	500	30
PFD144	Rc 3/4"	230V/1Ph/50Hz	85	144	750	360	550	50
PFD180	Rc 3/4"	230V/1Ph/50Hz	106	180	750	360	550	50
PFD216	Rc 3/4"	230V/1Ph/50Hz	127	216	750	360	550	55
PFD240	Rc 3/4"	230V/1Ph/50Hz	142	240	750	360	550	55

Nominal dryer flow rated at inlet pressure 7 barg, inlet air temperature 42°C, ambient temperature 38°C and dew point 3°C to 10°C. Refrigerant type R134a.

Product Selection

Correction factor for pressure barg (CP)

3	4	5	6	7	8	9	10	11	12	13	14	15
0.74	0.83	0.90	0.93	1.00	1.04	1.08	1.11	1.15	1.18	1.22	1.25	1.28

Correction factor for inlet air temperature (CT)

35°C	38°C	40°C	42°C	45°C	50°C	55°C	60°C
1.20	1.11	1.05	1.00	0.93	0.84	0.76	0.70

Correction factor for ambient temperature (CA)

25°C	30°C	35°C	38°C	40°C	45°C	50°C
1.15	1.10	1.02	1.00	0.89	0.79	0.69

1. Selected the correction factor (CP), (CT) and (CA).
2. Calculate the dryer capacity require using the following: Actual flow rate = Nominal flow rate x CP x CT x CA

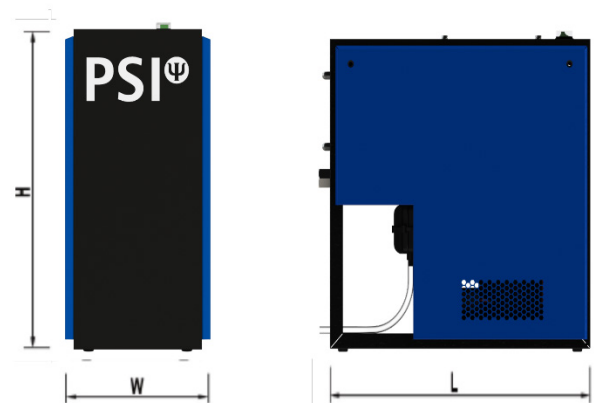

Technical Data PFD330 - PFD10800

Model	Air Connection	Power Supply	Nominal Flow Rate		Dimensions (mm)			Weight (kg)
			cfm	m ³ /h	L	W	H	
PFD330A	Rc 1 1/2'	400V/3Ph/50Hz	195	330	750	592	913	75
PFD390A	Rc 1 1/2'	400V/3Ph/50Hz	229	390	750	592	913	78
PFD510A	Rc 1 1/2'	400V/3Ph/50Hz	300	510	750	592	913	80
PFD600A	Rc 1 1/2'	400V/3Ph/50Hz	353	600	750	592	913	85
PFD720A	Rc 2"	400V/3Ph/50Hz	424	700	1000	710	1030	130
PFD900A	Rc 2"	400V/3Ph/50Hz	530	900	1000	710	1030	140
PFD1200A	Rc 2"	400V/3Ph/50Hz	706	1200	1000	710	1030	150
PFD1500A	Rc 2 1/2"	400V/3Ph/50Hz	883	1500	1000	820	1600	250
PFD1800A	Rc 2 1/2"	400V/3Ph/50Hz	1059	1800	1000	820	1600	260
PFD2100A	Rc 2 1/2"	400V/3Ph/50Hz	1236	2100	1000	820	1600	270
PFD2400A	DN100	400V/3Ph/50Hz	1412	2400	1250	1120	1750	500
PFD3000A	DN100	400V/3Ph/50Hz	1765	3000	1250	1120	1750	510
PFD3600A	DN100	400V/3Ph/50Hz	2118	3600	1250	1120	1750	550
PFD4200A	DN125	400V/3Ph/50Hz	2471	4200	1250	1120	1750	580
PFD4800A	DN150	400V/3Ph/50Hz	2824	4800	2000	1515	1770	700
PFD5400A	DN150	400V/3Ph/50Hz	3177	5400	2000	1515	1770	720
PFD6000A	DN150	400V/3Ph/50Hz	3530	6000	2000	1515	1770	940
PFD7200A	DN150	400V/3Ph/50Hz	4236	7200	2000	1515	1770	950
PFD9000W	DN200	400V/3Ph/50Hz	5295	9000	2135	1225	1800	1150
PFD10800W	DN200	400V/3Ph/50Hz	6354	10800	2135	1225	1800	1350

Nominal dryer flow rated at inlet pressure 7 barg, inlet air temperature 42°C, ambient temperature 38°C and dew point 3°C to 10°C. Refrigerant type R407C. Water-cooled version is available from PFD780 onwards.

Product Selection

Correction factor for pressure barg (CP)

3	4	5	6	7	8	9	10	11	12	13	14	15
0.74	0.83	0.90	0.93	1.00	1.04	1.08	1.11	1.15	1.18	1.22	1.25	1.28

Correction factor for inlet air temperature (CT)

35°C	38°C	40°C	42°C	45°C	50°C	55°C	60°C
1.20	1.11	1.05	1.00	0.93	0.84	0.76	0.70

Correction factor for ambient temperature (CA)

25°C	30°C	35°C	38°C	40°C	45°C	50°C
1.15	1.10	1.02	1.00	0.89	0.79	0.69

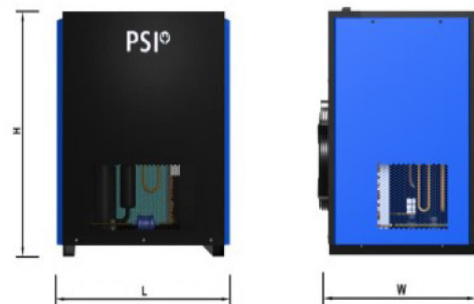

1. Selected the correction factor (CP), (CT) and (CA).
2. Calculate the dryer capacity require using the following: Actual flow rate = Nominal flow rate x CP x CT x CA

Technical Data PFD (High Inlet Temperature)

Model	Air Connection	Power Supply	Nominal Flow Rate		Dimensions (mm)			Weight (kg)
			cfm	m ³ /h	L	W	H	
PFD72T	Rc 1/2"	230V/1Ph/50Hz	42	72	650	320	550	35
PFD144T	Rc 1"	230V/1Ph/50Hz	85	144	800	420	600	70
PFD180T	Rc 1"	230V/1Ph/50Hz	106	180	800	420	600	75
PFD360T	Rc 1 1/2"	230V/1Ph/50Hz	212	360	750	695	1260	125
PFD480T	Rc 1 1/2"	230V/1Ph/50Hz	282	480	750	695	1260	128
PFD600T	Rc 1 1/2"	230V/1Ph/50Hz	353	600	750	695	1260	133
PFD720T	Rc 2"	230V/1Ph/50Hz	424	720	1000	840	1450	165
PFD900T	Rc 2"	230V/1Ph/50Hz	530	900	1000	840	1450	175

Nominal dryer flow rated at inlet pressure 7 barg, inlet air temperature 60°C ambient temperature 38°C and dew point 3°C to 10°C.

Product Selection

Correction factor for pressure barg (CP)

3	4	5	6	7	8	9	10	11	12	13	14	15
0.74	0.83	0.90	0.93	1.00	1.04	1.08	1.11	1.15	1.18	1.22	1.25	1.28

Correction factor for inlet air temperature (CT)

50°C	55°C	60°C	65°C	70°C	75°C	80°C
1.03	1.02	1.00	0.87	0.78	0.70	0.64

Correction factor for ambient temperature (CA)

25°C	30°C	35°C	38°C	40°C	45°C	50°C
1.15	1.10	1.02	1.00	0.89	0.79	0.69

1. Selected the correction factor (CP), (CT) and (CA).
2. Calculate the dryer capacity require using the following: Actual flow rate = Nominal flow rate x CP x CT x CA

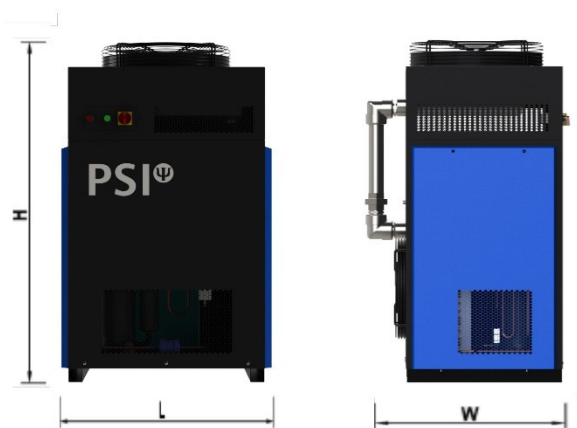

Technical Data PFD (High Pressure)

Model	Air Connection	Power Supply	Nominal Flow Rate		Dimensions (mm)			Weight (kg)
			cfm	m ³ /h	L	W	H	
PFD76P	Rc 1/2"	230V/1Ph/50Hz	42	76	600	310	500	35
PFD144P	Rc 3/4"	230V/1Ph/50Hz	85	144	750	360	550	50
PFD216P	Rc 3/4"	230V/1Ph/50Hz	127	216	750	360	550	55
PFD360P	Rc 1 1/4"	230V/1Ph/50Hz	212	360	750	550	880	80
PFD480P	Rc 1 1/4"	230V/1Ph/50Hz	282	480	750	550	880	80
PFD600P	Rc 1 1/4"	230V/1Ph/50Hz	353	600	750	550	880	80
PFD720P	Rc 1 1/4"	230V/1Ph/50Hz	424	720	750	550	880	80
PFD900P	Rc 1 1/4"	230V/1Ph/50Hz	530	900	1100	860	1200	150
PFD1200P	Rc 1 1/4"	230V/1Ph/50Hz	706	1200	1100	860	1200	150
PFD1500P	Rc 2 1/2"	400V/3Ph/50Hz	883	1500	1100	900	1550	270
PFD1800P	Rc 2 1/2"	400V/3Ph/50Hz	1059	1800	1100	900	1550	270
PFD2100P	Rc 2 1/2"	400V/3Ph/50Hz	1236	2100	1100	900	1550	300
PFD2400P	Rc 2 1/2"	400V/3Ph/50Hz	1412	2400	1100	900	1550	350
PFD3000P	Rc 2 1/2"	400V/3Ph/50Hz	1766	3000	1100	900	1550	470
PFD3600P	DN80	400V/3Ph/50Hz	2119	3600	1450	1130	1650	550
PFD4200P	DN80	400V/3Ph/50Hz	2472	4200	1450	1130	1650	570
PFD4800P	DN80	400V/3Ph/50Hz	2825	4800	1450	1130	1650	600

Nominal dryer flow rated at inlet pressure 40 barg, inlet air temperature 38°C, ambient temperature 38°C and dew point 3°C to 10°C.

Product Selection

Correction factor for pressure barg (CP)

20	25	30	35	40	45
0.91	0.94	0.97	0.99	1.00	1.01

Correction factor for inlet air temperature (CT)

35°C	38°C	40°C	42°C	45°C	50°C	55°C	60°C
1.11	1.00	0.97	0.92	0.85	0.77	0.69	0.56

Correction factor for ambient temperature (CA)

25°C	30°C	35°C	38°C	40°C	45°C	50°C
1.15	1.10	1.02	1.00	0.89	0.79	0.69

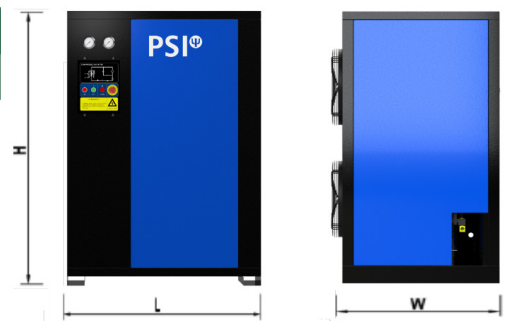

1. Selected the correction factor (CP), (CT) and (CA).
2. Calculate the dryer capacity require using the following: Actual flow rate = Nominal flow rate x CP x CT x CA



PSI Filtration Technology Co. Ltd

Glenarm Road, Wynyard Park,
Stockton-on-Tees, TS22 5FE, UK

Asia Contact: +65 9752 8469

[www. psiair.co.uk](http://www.psiair.co.uk)



**INVESTORS
IN PEOPLE**



PSI reserve the right to change the specifications without prior notice.

Published version: 1804